



POLARIS
RZR^{XP} TURBO S
**ALUMINUM ROOF &
OVERHEAD CONSOLE**
PRODUCT MANUAL



Part Numbers: RBO8007, RBO8010



PRODUCT MANUAL INFORMATION

INTRODUCTION

Everyone here at Razorback Offroad™ would like to thank you for your recent purchase of one of our products, and tell you congratulations! Our passion is to provide our customers with the best products and parts money can buy! Without support from valued customers such as yourselves, our business, as well as the people who work for it, wouldn't survive. We hope you find our products useful and get the most out of every experience with them. Thank you!



ATTENTION

This manual should be read carefully. It contains important information that needs to be fully understood and followed in order to ensure that the Razorback Offroad products discussed in this manual are used properly so as to ensure the safety of all persons (e.g. operators, customers, bystanders).

MIXING & MATCHING PRODUCTS

- Only use Razorback Offroad brand replacement parts for your Razorback Offroad products.

ALWAYS FOLLOW STATE & LOCAL GUIDELINES!

 **SECUREMENT** It is the driver's / operator's responsibility to ensure that nothing can come loose from any part of their vehicle. It is the operator's responsibility to make sure that all items are in good working order and are properly secured!

 **MODIFICATION** **DO NOT** modify or tamper with any RBO product. Doing so will void any applicable warranty and may result in serious injury or death. • Warranties will be voided if any RBO Product is modified or tampered with!

 **INSPECTION** RBO requires that each operator of a vehicle perform a detailed circle check before and after each use of the vehicle. This inspection must include the power unit, the vehicle, and all items installed on the vehicle.

- Do not take chances with your life or other people's lives. Make sure all items are secured and in safe working order.
- Always inspect products for any signs of paint cracking, metal fatigue, or premature wear.
- Maintain a visual inspection along with grabbing the product and wiggling or pulling on it to make sure there is no way anything can become dislodged from the machine.
- Remove from service immediately if repairs are needed. Do not take chances.

 **WARNING** Operating, servicing, and maintaining a passenger vehicle or off-road vehicle can expose you to chemicals including engine exhaust, carbon monoxide, phthalates, and lead, which are known to the State of California to cause cancer and birth defects or other reproductive harm. To minimize exposure, avoid breathing exhaust, do not idle the engine except as necessary, service your vehicle in a well-ventilated area, and wear gloves or wash your hands frequently when servicing your vehicle.

For more information go to www.P65Warnings.ca.gov/passenger-vehicle

TERMS & CONDITIONS

RBO0166R1

LIMITATION ON WARRANTY

Inventive Edge, LLC dba RazorBack Offroad™ (also referred to herein as RBO) warrants to the original purchaser that each new RazorBack Offroad™ (RBO) product will be free from defects in material and workmanship for a period of twelve (12) months from date of purchase.

RBO's obligation under this warranty, statutory or otherwise, is limited to the repair or replacement at the RBO factory, or at a point designated by RBO, of such part or parts as shall appear upon inspection by RBO to be defective in material or workmanship. In no event shall RBO accept such notification later than twelve (12) months from date of purchase. This warranty is not transferable.

Except as expressly set forth in this warranty, RBO makes no other warranty, express or implied, and hereby disclaims all other warranties including, but not limited to, the implied warranties of merchantability and fitness for a particular purpose. RBO shall in no event be liable for claimed downtime, claimed loss of profits or goodwill, or any other special, incidental, indirect, or consequential damages concerning or relating to any product or parts, whether based on negligence, strict liability, breach of contract, breach of warranty, misrepresentation, or any other legal theory, regardless of whether the loss resulted from any general or particular requirement which RBO knew or had reason to know about at the time of sale.

RBO makes no warranty, express or implied, as to the finished products manufactured or supplied by another manufacturer and supplied by RBO to purchaser, including, but not limited to, any boat or vehicle to which an RBO product may be affixed or any accessories, and RBO expressly disclaims any implied warranties of merchantability and fitness for a particular purpose as to such equipment or products. This language shall in no way affect or diminish the rights of the purchaser to rely on such warranties as are extended by such manufacturers or supplies. RBO shall, to the extent permitted under applicable law, pass on to the purchaser such manufacturer's or seller's warranty.

RBO, whose policy is one of continuous improvement, reserves the right to improve its products through changes in design or materials as it may deem desirable without being obligated to incorporate such changes in products previously sold.

This warranty is not intended to cover or include the following items, which are set forth by way of example and not limitation:

- Normal deterioration of trim, paint, lettering, appearance of items due to wear or exposure to weather, etc.
- Any damage or defect due to accident, misuse, abuse, operation exceeding rated loads, Improper or unauthorized repairs, failure to provide reasonable and necessary maintenance, or uses of which the equipment was not designed or intended.
- Alterations or modifications that affect performance, operations, or reliability.

Products Covered

All Products carrying the Razorback Offroad™ (RBO) name. (All other products purchased from other manufacturers are limited to that manufacturer's warranty.)

RBO 100% Money Back Guarantee:

The RBO 100% Money back guarantee pertains to any Razorback Offroad™ (RBO) Branded product purchased online directly from RBO. If you are not 100% satisfied with the product for any reason, just return the product back to RBO and RBO will refund 100% of the purchase price of the product. In order to receive refund for product return, RBO must be notified in writing or via email within 30 days of product purchase that user wishes to return product. In order for a product to qualify for the 100% money back guarantee, claim must be filed within 30 days of purchase date. Once the product is returned to RBO, RBO will send a check to the user to cover the initial product cost less freight charges if any. This offer does not include freight or transportation cost (See Return Policy). It is the responsibility of the purchaser to pay all freight charges. In no way will RBO be responsible to refund freight cost to end user. If RBO determines that the product was blatantly destroyed or damaged due to negligence of the purchaser, this refund offer will be null and void.

This warranty does not obligate RBO to bear the cost of labor or transportation charges in connection with the repair or replacement of any parts found to be defective, nor shall it apply to a product upon which repairs or alterations have been made unless authorized by RBO.

Return Policy

The Purchaser, when returning a Product, must follow the following steps:

1. The Purchaser must have proof of purchase of any damaged Product. The Purchaser must obtain from Razorback Offroad™ (RBO) a Returned Merchandise Authorization (RMA) will be given along with the correct address where to ship the damaged product.
2. The Purchaser must pay all shipping costs to deliver the damaged Products to RBO and must send the damaged Product along with the RMA and proof of purchase together.
3. Upon receipt of damaged Product, RBO will determine whether the damaged Product is covered under the Limited Warranty. If it is, RBO will repair or replace the Product. If the Product is replaced, the Product that is originally returned by the Purchaser shall become the exclusive property of RBO. If the returned Product is not covered under the Limited Warranty, RBO will notify the Purchaser before taking any further action with regard to repair or replacement, which would be at the Purchaser's cost.
4. Customer is responsible to pay shipping charges to RBO for product inspection. RBO will pay return freight if product is found to be under warranty using UPS Ground or equivalent.
5. If customer would like to have their product returned overnight or via rapid freight methods, RBO will give customer the option to pay for rapid freight options.

TERMS & CONDITIONS

RBO0166R1

Notice to Owner or User

It is the responsibility of the Owner or User to go to our Product Registration page to register your RBO product. Failure to register product will void any expressed or implied warranties of RBO products. Filling out your online warranty registration is very important in the event that RBO should ever need to contact you concerning the compliance of your registered equipment with any applicable safety standards, the information you have provided on the warranty registration transfer below will ensure your immediate notification. User should also read and understand all operations manuals pertaining to the product purchased. User should also consult with all manufacturer's operations manuals regarding the addition of aftermarket products to their machines to make sure that RBO products can be used without affecting the machine's performance and handling. When in doubt please consult with your local UTV dealer.

For more information regarding Safe operation of your Off-Road Vehicle Please go to www.rohva.org or similar organization.

LIMITATION OF LIABILITY

RBO's total liability for any and all losses and damages arising out of any cause whatsoever shall in no event exceed the purchase price of the products or parts in respect of which such cause arises, whether such cause be based on theories of contract, negligence, strict liability, tort or otherwise. Inventive Edge LLC shall not be liable for incidental, consequential or punitive damages or other losses. Inventive Edge LLC shall not be liable for, and consumer assumes liability for, all personal injury and property damage connected with the handling, transportation, possession, installation, other use or resale of the product, whether used alone or in combination with any other product or material. If Inventive Edge LLC furnishes technical advice to consumer, whether or not at consumer's request, with respect to installation, application, or use of the product and/or its related parts, Inventive Edge LLC shall not be liable for such technical advice and buyer assumes all risks of such advice and the results there of.

NOTE: Some states do not allow the limitation or exclusion of incidental or consequential damages, so the above limitations or exclusions, wholly or partially, may not apply. The portions of this limited warranty and limitation of liability shall be considered severable and all portions that are not disallowed by applicable law shall remain in full force and effect.

Never ride beyond your ability. Off-road vehicles can be hazardous to operate and are not intended for on-road use. Driver must be at least 16 years old with a valid driver's license to operate. Passengers, if permitted, must be at least 12 years old. All drivers should always wear helmets, eye protection, and protective clothing. Always use seat belts and cab nets or doors (as equipped). Never engage in stunt driving, and avoid excessive speeds and sharp turns. Riding and alcohol/drugs don't mix. All riders should take a safety training course. Check local laws before riding on trails.

Duties and Taxes:

Import duties, taxes, and brokerage fees are not included in the product price or shipping and handling cost and it will be collected upon delivery from the carriers for certain packages. These charges are recipient's responsibility as we are only charging the transportation fee for the packages. You may check with your country's customs office to determine what these additional costs will be. Additionally, you may review below additional information for shipments shipping to Canada which can imply to other countries as well.

Additional Information: Below are some additional information regarding international shipments going to Canada you may reference as well as refer to sites such as www.thefinalcost.com in order to get an estimate on these import costs.

Fees for Canada orders:

Brokerage Fees

The brokerage fees are a processing fee charged by the shipping company. This fee includes filling in a customs form to indicate the contents and value of the shipment and calculating duty and taxes.

UPS

When UPS Customs Brokerage handles your imports, there is no Entry Preparation Fee for routine customs clearance of UPS Worldwide Express Plus, UPS Worldwide Express, UPS Worldwide Express Saver, and UPS Worldwide Expedited shipments, including up to five classification lines. Charges may apply for more complex customs clearance procedures.

(Source: http://www.ups.com/content/ca/en/shipping/cost/zones/customs_clearance.html)

Taxes

Each item entering Canada will be charged GST (General Sales Tax) and PST (Provincial Sales Tax – varies by province) based on the declared value.

*Razorback Offroad will not declare any false information on the customs form to avoid or reduce these fees.

POLARIS® **RZR^{XP}** **TURBO S** **4 SEAT ALUMINUM ROOF**

PART#	DESCRIPTION
RB08007	Polaris Turbo S 4 Seat™ Aluminum Roof (MOUNTING HARDWARE INCLUDED)

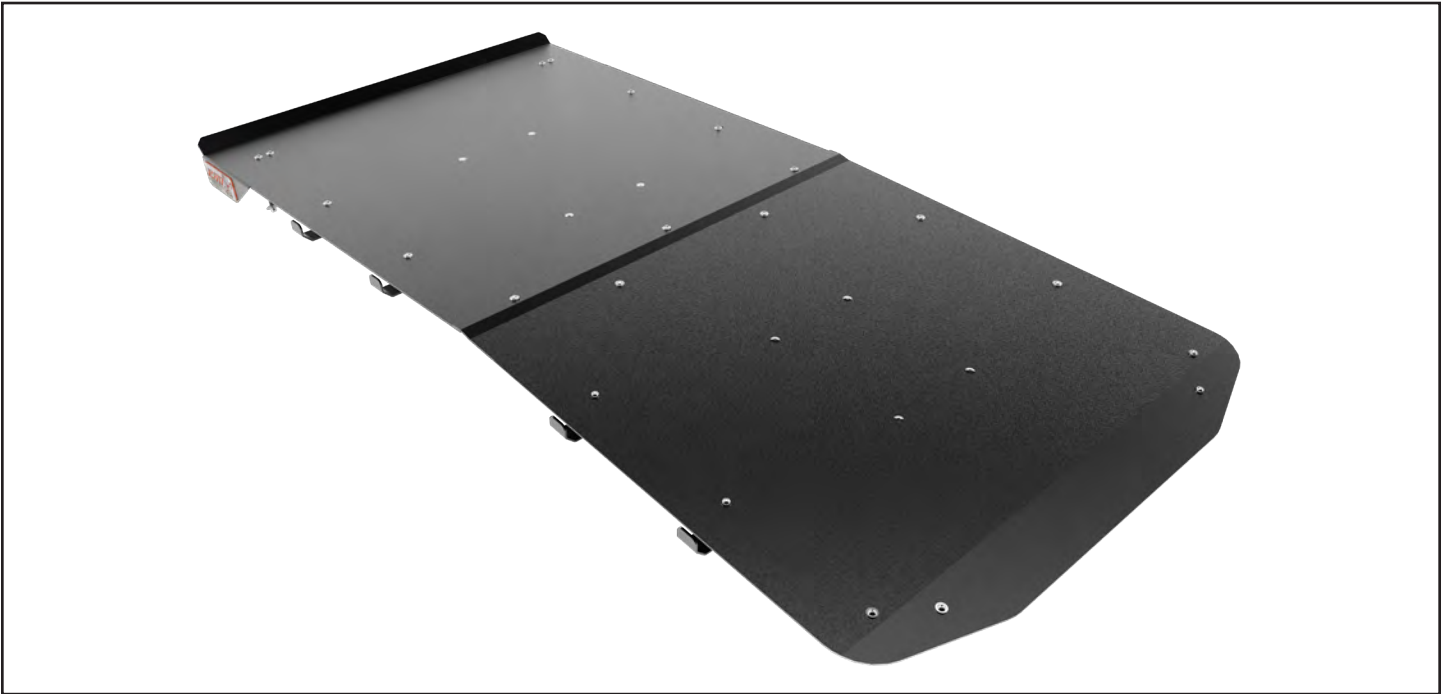

When it comes to our Polaris RZR® Turbo S 4-Seat roof, we wanted to make the toughest roof on the market while maintaining a good-looking, sleek design. We know how these machines are treated, and it's not rare for them to end up putting their roll cages to the test. For that reason, we chose high-strength lightweight 1/8" aluminum and finished it with a tough powder coat black finish. We went all out, designing what we feel is the strongest roof on the market. What's the next thing to look for in a roof? Silence! We went ahead and put a 1/2" compression gasket between the roof and any point that may contact the cage to eliminate any possibility of squeaks or rattles. Next, we knew this roof needed to be easy to install so we used our RBO Fast-Clamp™ System. This Polaris® Turbo S 4 seat roof is completely bolt-on with no drilling required! As for the looks of this roof, we designed it to perfectly follow the factory contours of your stock cage and gave it a little RBO flare at the end with a small up-kicked wing at the back. If you want to go one step further, this roof has all of the pre-cut mounting holes to easily add our "Optional" Polaris RZR® Turbo S 4-Seat and Polaris® Turbo S Velocity Overhead Console. Made in the USA with pride, by people who drive these machines and enjoy the off-road life. (Make sure to check out the video)

 **Failure to follow the safety guidelines listed may result in voiding any applicable warranty, serious bodily injury, or death.**

 It is very important that you properly fill out your product registration form at razorbackoffroad.com/product-registration/ to register your equipment. By submitting the information within 15 days of your purchase, your warranty will be validated, ensuring that your equipment will be protected subject to the terms and conditions set out herein. In the event we need to contact you concerning your registered equipment, Product Updates, Service Bulletins, or Product Recalls, the information you have provided on the product registration form will ensure your immediate notification. Do your part and let us help you by filling out your product registration form.



INCLUDED MOUNTING HARDWARE

- 1/4" Flange NylockNut (17)
- 1/4"-20 x 3/4" 18-8 SS Button Head Cap Screw Black Oxide (17)
- 1/4" 18-8 SS Flat Washer Black Oxide (21)
- M6-1.0x20mm Button Head Socket Cap Screw 18-8 SS Black Oxide (4)
- 10-24 x 3/4" SS Machine Screw (4)
- 10-24 Flange Nut Nylock (4)
- Aluminum Spacers (4)
- M6 x 1.0 mm Hex Shank Tap (1)

TOOLS REQUIRED FOR INSTALLATION

- 1/4" Box Wrench/Socket
- 3/8" Box Wrench/Socket
- 7/16" Box Wrench/Socket
- 4mm Allen Wrench
- 5/32" Allen Wrench
- Phillips Head Screwdriver

 **Failure to follow the safety guidelines listed may result in voiding any applicable warranty, serious bodily injury, or death.**

 It is very important that you properly fill out your product registration form at razorbackoffroad.com/product-registration/ to register your equipment. By submitting the information within 15 days of your purchase, your warranty will be validated, ensuring that your equipment will be protected subject to the terms and conditions set out herein. In the event we need to contact you concerning your registered equipment, Product Updates, Service Bulletins, or Product Recalls, the information you have provided on the product registration form will ensure your immediate notification. Do your part and let us help you by filling out your product registration form.

INSTALLATION INSTRUCTIONS

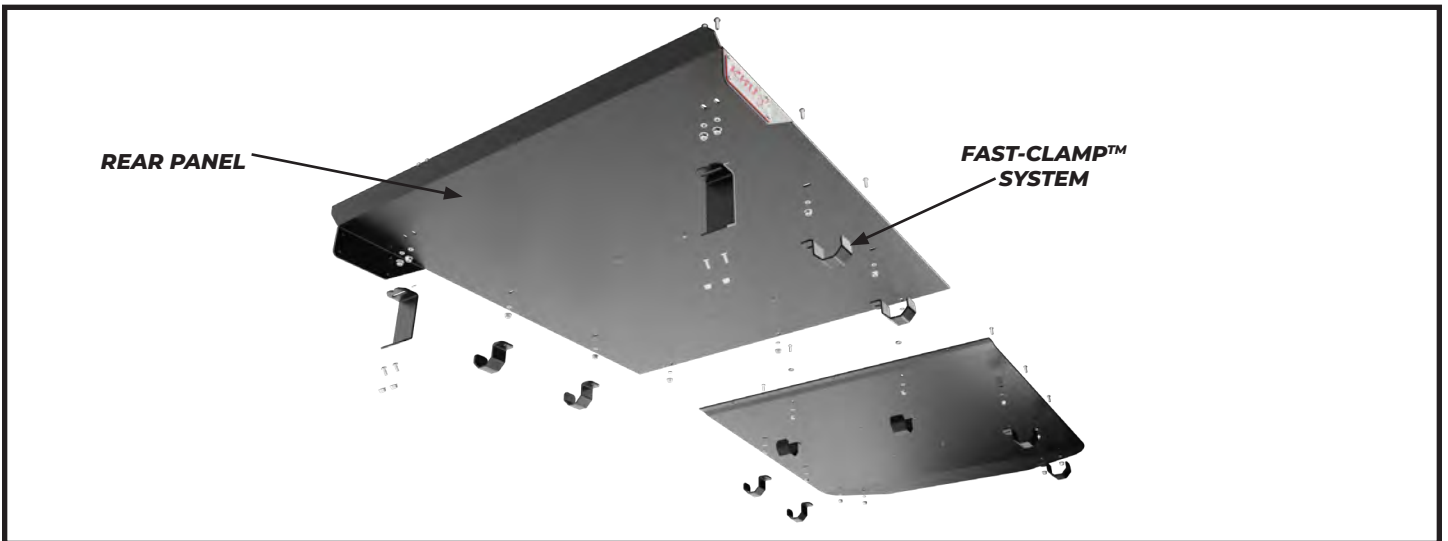
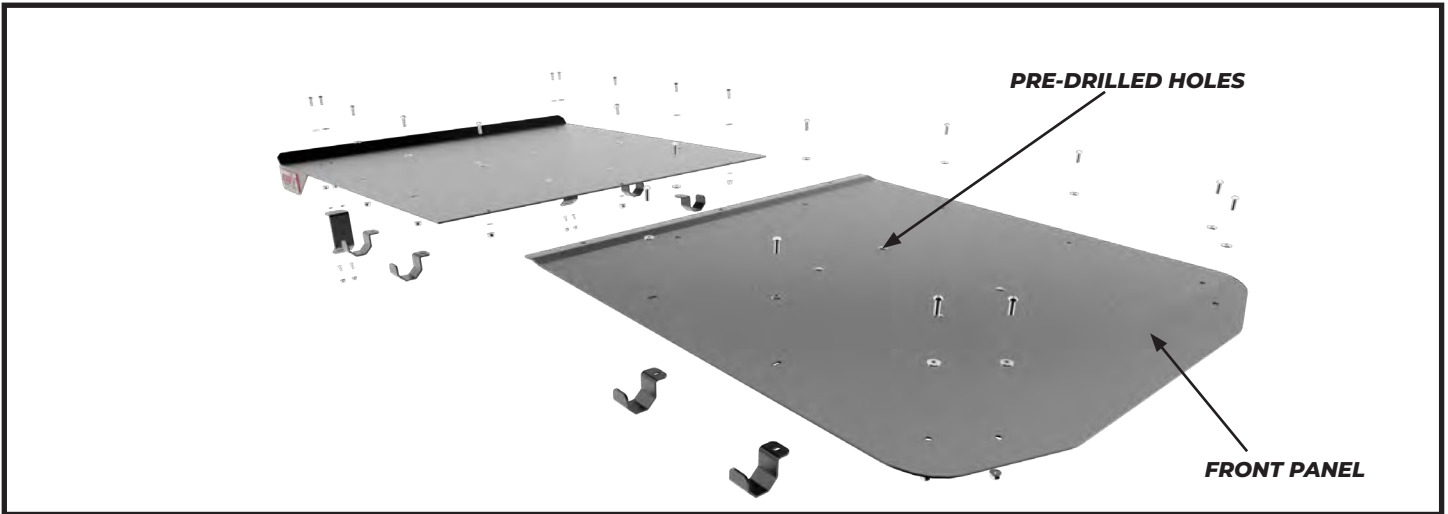

FOLLOW THE INSTRUCTIONS TO GET TO THE VIDEO ON THE NEXT PAGE:

 Failure to follow the safety guidelines listed may result in voiding any applicable warranty, serious bodily injury, or death.

 It is very important that you properly fill out your product registration form at razorbackoffroad.com/product-registration/ to register your equipment. By submitting the information within 15 days of your purchase, your warranty will be validated, ensuring that your equipment will be protected subject to the terms and conditions set out herein. In the event we need to contact you concerning your registered equipment, Product Updates, Service Bulletins, or Product Recalls, the information you have provided on the product registration form will ensure your immediate notification. Do your part and let us help you by filling out your product registration form.

STEP 1 Head over to [youtube.com](https://www.youtube.com)

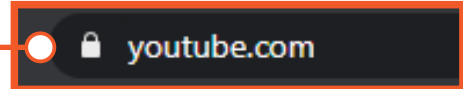

STEP 2 Search for "Razorback Offroad" in the search bar.



STEP 3 Find our channel. Be sure to hit subscribe!

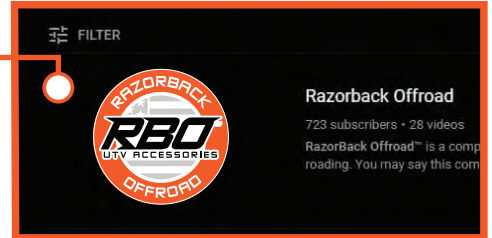

STEP 4 Click on "Playlists" to view all of our playlists.

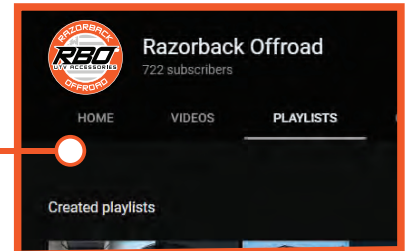

STEP 5 Head over to the "Installation Videos" playlist.

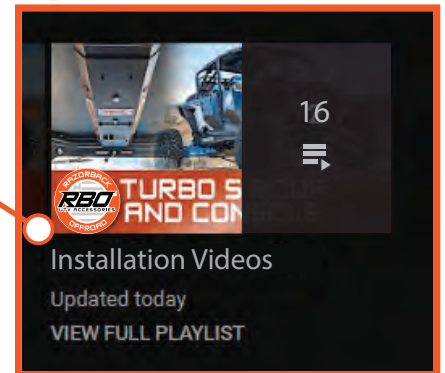

STEP 6 Find the video titled "Polaris RZR Turbo S Roof and Console - Overview by Razorback Offroad™".

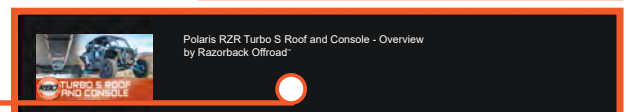

STEP 7 Sit back, learn, and enjoy!

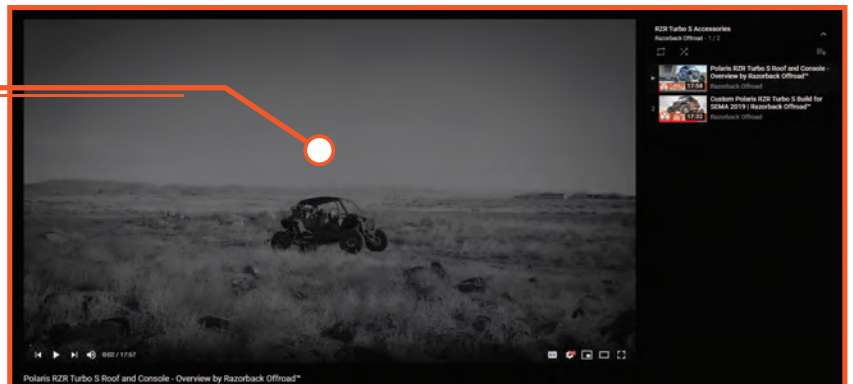

BE SURE TO LIKE & SUBSCRIBE FOR MORE CONTENT!

⚠️ Failure to follow the safety guidelines listed may result in voiding any applicable warranty, serious bodily injury, or death.

⚠️ It is very important that you properly fill out your product registration form at razorbackoffroad.com/product-registration/ to register your equipment. By submitting the information within 15 days of your purchase, your warranty will be validated, ensuring that your equipment will be protected subject to the terms and conditions set out herein. In the event we need to contact you concerning your registered equipment, Product Updates, Service Bulletins, or Product Recalls, the information you have provided on the product registration form will ensure your immediate notification. Do your part and let us help you by filling out your product registration form.

POLARIS  **RZR^{XP} TURBO S** 4 SEAT OVERHEAD CONSOLE

PART#	DESCRIPTION
RB08010	Polaris Turbo S 4 Seat™ Overhead Console (MOUNTING HARDWARE INCLUDED)

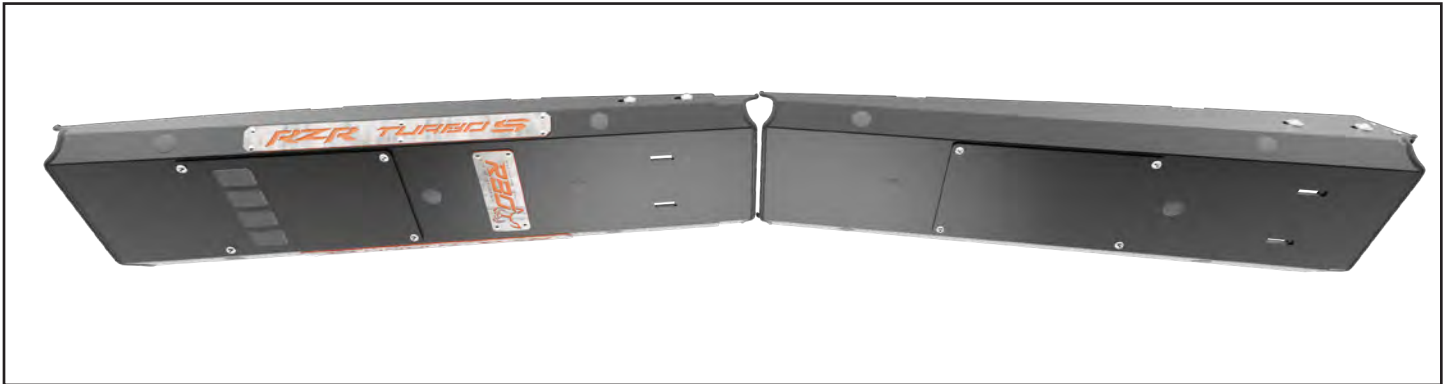

Safety, Looks, and Functionality. The RBO Polaris RZR® Turbo S 4 Seat Overhead Console gives you all 3. When we first started developing this console, we wanted to find a way to increase the roof strength in the event we rolled our Polaris RZR® Turbo S over. On a stock Polaris RZR® Turbo S Velocity, there is no center roof bar. With our Polaris Turbo S console, we have designed in a locking system that firmly locks the console into the main roll cage supports, adding yet another layer of roof support. We designed this console to be secured only with our roof, and it comes pre-drilled so installation is easy as can be using only basic hand tools. The console comes with (12) pre-cut 3/4" holes in case you want to add some of our optional Red or White LED lights. Each of the 12 pre-cut Light holes comes with a plastic plug in case you don't want to use them. We also include a removable switch panel that has 4 switch locations in the event you want overhead switches. After you look this console over, you can see why it's become such a popular addition to the 4 seat Polaris® XP Turbo S and the Polaris Turbo S Velocity Side x Sides. This overhead console is made from aluminum, comes in our black powder-coated finish, and includes all the mounting hardware required for installation. We are proud to say this is American-Made and comes with our 30-day money-back guarantee! (Make sure to check out the video)

 **Failure to follow the safety guidelines listed may result in voiding any applicable warranty, serious bodily injury, or death.**

 It is very important that you properly fill out your product registration form at razorbackoffroad.com/product-registration/ to register your equipment. By submitting the information within 15 days of your purchase, your warranty will be validated, ensuring that your equipment will be protected subject to the terms and conditions set out herein. In the event we need to contact you concerning your registered equipment, Product Updates, Service Bulletins, or Product Recalls, the information you have provided on the product registration form will ensure your immediate notification. Do your part and let us help you by filling out your product registration form.



INCLUDED MOUNTING HARDWARE

- $\frac{1}{4}$ "-20 x $\frac{3}{4}$ " 18-8 SS Button Head Cap Screw Black Oxide (24)
- $\frac{1}{4}$ " 18-8 SS Flat Washer Black Oxide (16)

TOOLS REQUIRED FOR INSTALLATION

- $\frac{7}{16}$ " Box Wrench
- $\frac{5}{32}$ " Allen Wrench
- RBO Tensioner Tool (Supplied with console)

 **Failure to follow the safety guidelines listed may result in voiding any applicable warranty, serious bodily injury, or death.**

 It is very important that you properly fill out your product registration form at razorbackoffroad.com/product-registration/ to register your equipment. By submitting the information within 15 days of your purchase, your warranty will be validated, ensuring that your equipment will be protected subject to the terms and conditions set out herein. In the event we need to contact you concerning your registered equipment, Product Updates, Service Bulletins, or Product Recalls, the information you have provided on the product registration form will ensure your immediate notification. Do your part and let us help you by filling out your product registration form.

INSTALLATION INSTRUCTIONS

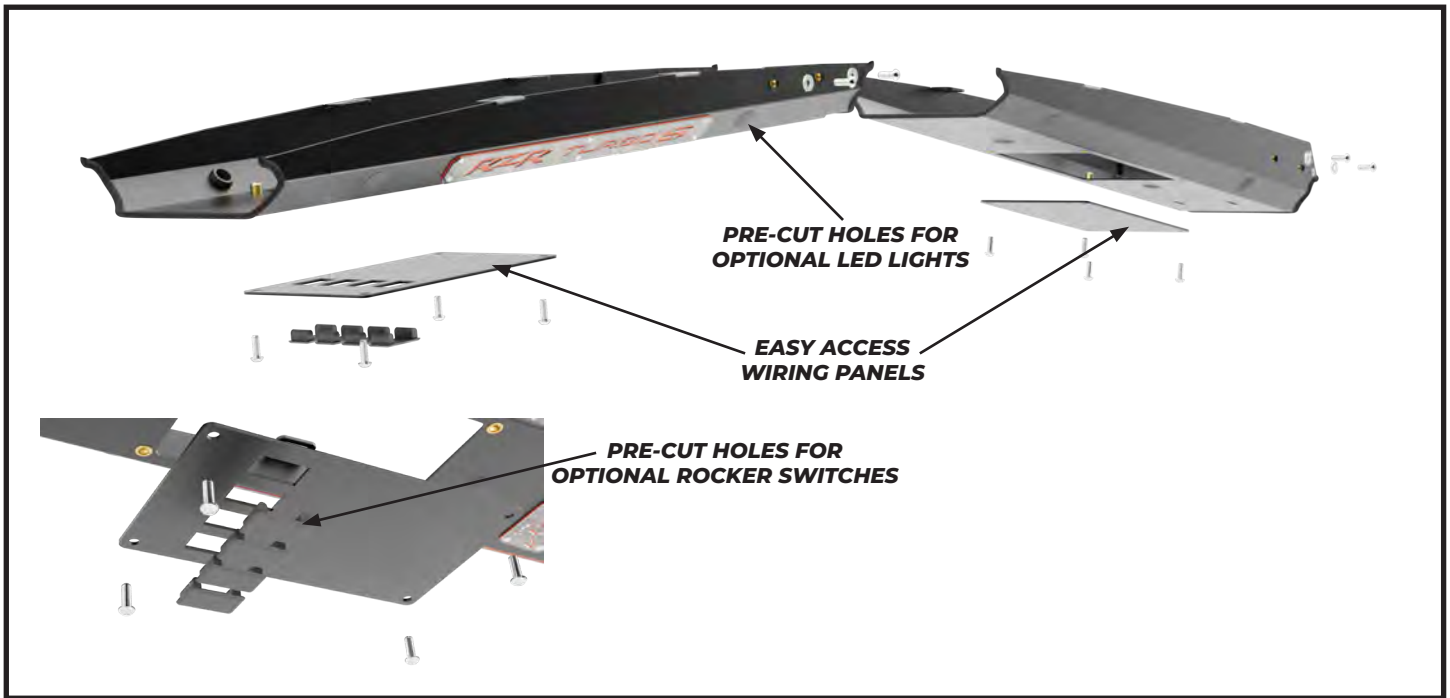

FOLLOW THE INSTRUCTIONS TO GET TO THE VIDEO ON THE NEXT PAGE:

 Failure to follow the safety guidelines listed may result in voiding any applicable warranty, serious bodily injury, or death.

 It is very important that you properly fill out your product registration form at razorbackoffroad.com/product-registration/ to register your equipment. By submitting the information within 15 days of your purchase, your warranty will be validated, ensuring that your equipment will be protected subject to the terms and conditions set out herein. In the event we need to contact you concerning your registered equipment, Product Updates, Service Bulletins, or Product Recalls, the information you have provided on the product registration form will ensure your immediate notification. Do your part and let us help you by filling out your product registration form.

STEP 1 Head over to youtube.com



STEP 2 Search for "Razorback Offroad" in the search bar.



STEP 3 Find our channel. Be sure to hit subscribe!

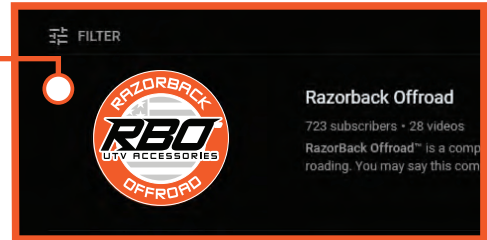

STEP 4 Click on "Playlists" to view all of our playlists.

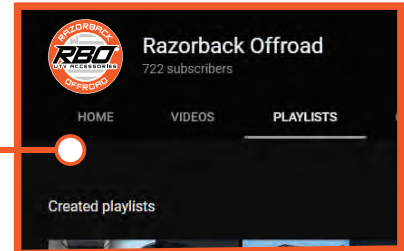

STEP 5 Head over to the "Installation Videos" playlist.

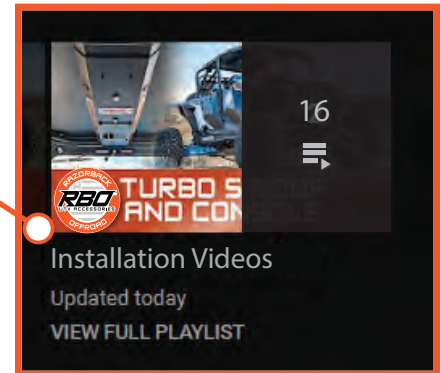

STEP 6 Find the video titled "Polaris RZR Turbo S Roof and Console - Overview by Razorback Offroad™".

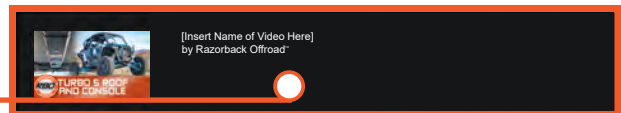

STEP 7 Sit back, learn, and enjoy!

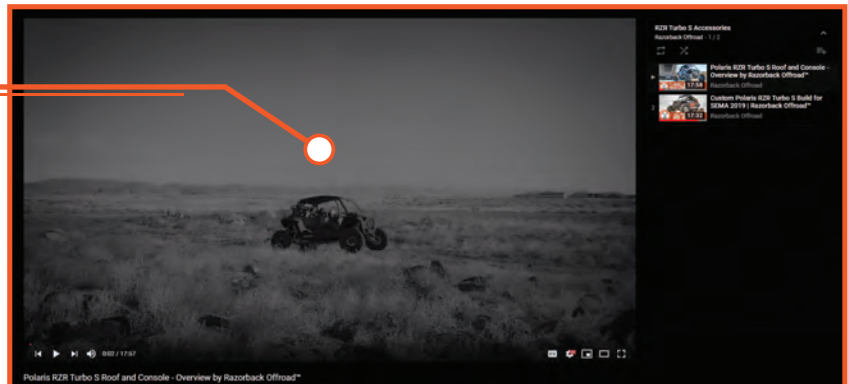

BE SURE TO LIKE & SUBSCRIBE FOR MORE CONTENT!

⚠️ Failure to follow the safety guidelines listed may result in voiding any applicable warranty, serious bodily injury, or death.

⚠️ It is very important that you properly fill out your product registration form at razorbackoffroad.com/product-registration/ to register your equipment. By submitting the information within 15 days of your purchase, your warranty will be validated, ensuring that your equipment will be protected subject to the terms and conditions set out herein. In the event we need to contact you concerning your registered equipment, Product Updates, Service Bulletins, or Product Recalls, the information you have provided on the product registration form will ensure your immediate notification. Do your part and let us help you by filling out your product registration form.

Go to [RAZORBACKOFFROAD.COM/PRODUCT-REGISTRATION](https://razorbackoffroad.com/product-registration)
for product registration
ITS AS EASY AS THESE 3 STEPS!

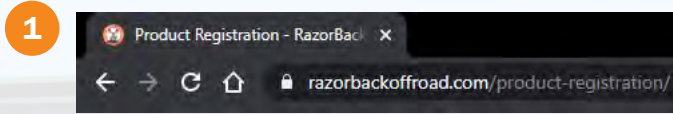

In your browser, navigate to razorbackoffroad.com/product-registration

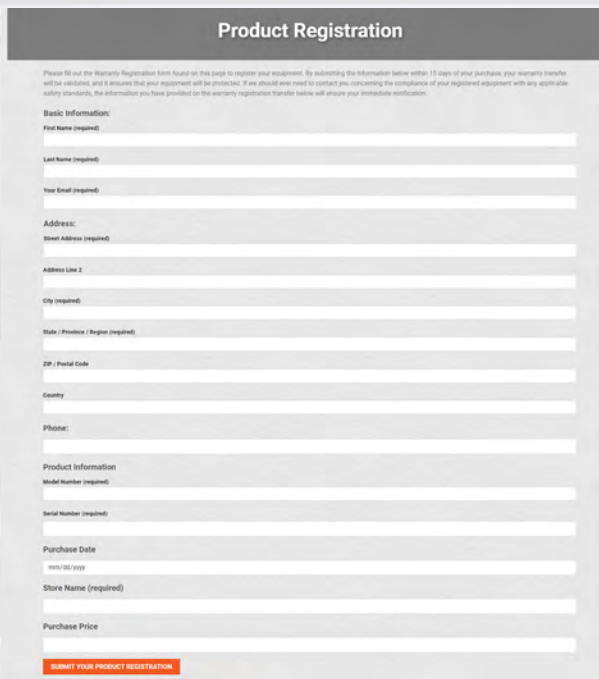
2 

Complete the form located on the product registration page.

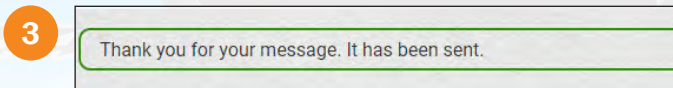

After completing the form, click on the "SUBMIT YOUR PRODUCT REGISTRATION" button and you're all set!

It is very important that you properly fill out your product registration form at razorbackoffroad.com/product-registration (follow the screenshots above) to register your equipment. By submitting the information within 15 days of your purchase, your warranty will be validated, ensuring that your equipment will be protected subject to the terms and conditions set out herein. In the event we need to contact you concerning your registered equipment, Product Updates, Service Bulletins, or Product Recalls, the information you have provided on the product registration form will ensure your immediate notification. Do your part and let us help you by filling out your product registration form. Please fill out the product registration form at razorbackoffroad.com/product-registration within 15 days after purchase. This validates the warranty transfer and is essential for your protection. If RBO should ever need to contact you concerning compliance of your RBO equipment with any applicable safety standards, the information you have provided on the product registration form will ensure your immediate notification.

In the event you were not the original purchaser of the product, we still need you to register your Razorback Offroad product.

PLEASE TAKE THE TIME TO FILL OUT THE PRODUCT WARRANTY FORM.

GO TO: [RAZORBACKOFFROAD.COM/PRODUCT-REGISTRATION](https://razorbackoffroad.com/product-registration)

IF YOU HAVE ANY QUESTIONS PLEASE CALL RAZORBACK OFFROAD: [1-208-696-7230](tel:1-208-696-7230)